



## Wall recessed luminaires

**IP 65** Dusttight and Jetproof conforming to DIN, VDE, IEC.  
**Class I.**

This wall recessed unit is a member of our rectangular shape collection with compact appearance. It provides the most pleasing and even light distribution which facilitates safe pedestrian traffic amongst walkways and stairways by creating visual continuity and highlighting the walkways. The lower lamp wattages have significantly reduced the energy consumption of the units thus reducing the heat generated and the associated running costs.

- Dusttight and Jetproof
  - Corrosion resistant die cast aluminium body and faceplate
  - UV stabilized and vandal resistant polycarbonate diffuser or safety glass lens on request
  - Stainless steel screws
  - Silicone rubber gasket
  - Integral control gear
  - Open with tools only
  - M 20x1.5 cable entries diameter 7.5 - 13.5 mm.
  - Ultraviolet stabilized polyester powder coat finish in Black RAL 9005
  - Other colours available upon consultation
- Galvanized steel sheet or aluminium sheet blackout on request

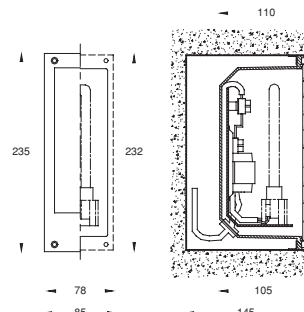
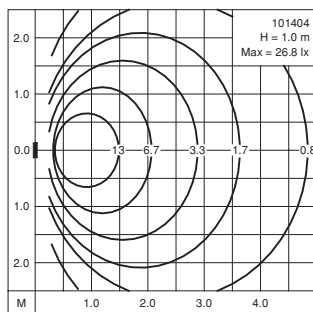
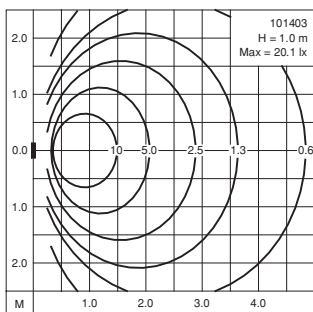

			Lumen
<b>101401</b>	Incandescent	E14 : 40W	400
<b>101402</b>	Compact fluorescent	G23 : 5/7/9W	250/400/600
<b>101403</b>	Compact fluorescent	G24d-1 : 10/13W	600/900
<b>101404</b>	Compact fluorescent	G24d-2 : 18W	1200