

Wall recessed luminaires

IP 65 Dusttight and Jetproof conforming to DIN, VDE, IEC.
Class I.

This wall recessed unit is a member of our rectangular shape collection with compact appearance. It features energy efficient lamps for functional direct illumination. The unit provides less glare from low mounting heights which enables designers to create visual continuity, wall grazing lighting effects, highlighting the floor.

The robust construction makes the luminaires ideal for specification in most commercial or public areas.

- Dusttight and Jetproof
- Corrosion resistant die cast aluminium body and faceplate
- UV stabilized and vandal resistant polycarbonate diffuser or safety glass lens on request
- Stainless steel screws
- Silicone rubber gasket
- Integral control gear
- Open with tools only
- M 20x1.5 cable entries diameter 7.5 - 13.5 mm.
- Ultraviolet stabilized polyester powder coat finish in Black RAL 9005
- Other colours available upon consultation

- Galvanized steel sheet or aluminium sheet blackout on request

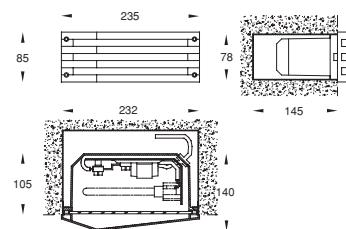
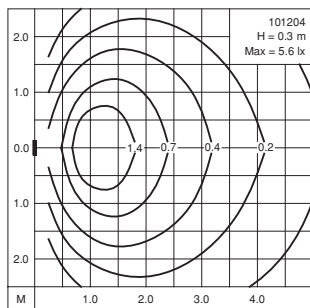
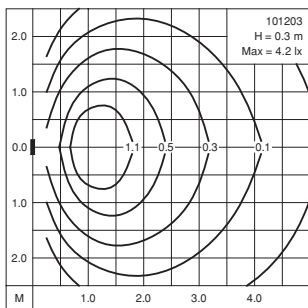

			Lumen
101201	Incandescent	E14 : 40W	400
101202	Compact fluorescent	G23 : 5/7/9W	250/400/600
101203	Compact fluorescent	G24d-1 : 10/13W	600/900
101204	Compact fluorescent	G24d-2 : 18W	1200