

Pole Top Luminaires

IP 55 Dustproof and Jetproof conforming to DIN, VDE, IEC.
Class I.

These luminaires with rotationally symmetrical light distribution and additional upper light access output are designed for pole heights of 3000-4000 mm providing a pleasant glarefree lighting suitable for private and public areas, hotels, parks, gardens and pedestrian precincts.

- Vandal resistant
- Corrosion resistant die cast aluminium alloy
- Stainless steel screws
- Ultraviolet stabilized polycarbonate diffuser in white opal or clear with anodized high purity aluminium reflector
- Weatherproof and durable silicone rubber gasket
- Integral control gear

- For die cast aluminium cone top cover and clear polycarbonate diffuser, please add "-CCL" after the six digits
- For die cast aluminium cone top cover and white opal polycarbonate diffuser, please add "-CWO" after the six digits
- For die cast aluminium bevelled top cover and clear polycarbonate diffuser, please add "-BCL" after the six digits
- For die cast aluminium bevelled top cover and white opal polycarbonate diffuser, please add "-BWO" after the six digits

Colour : Ultraviolet stabilized polyester powder coat finish in Black RAL 9005. Other colours are available upon consultation.

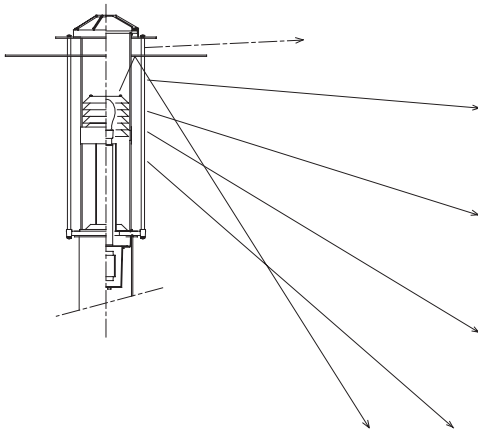

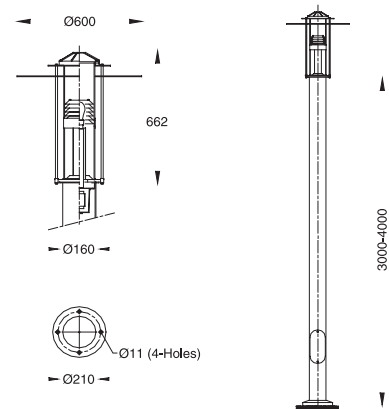
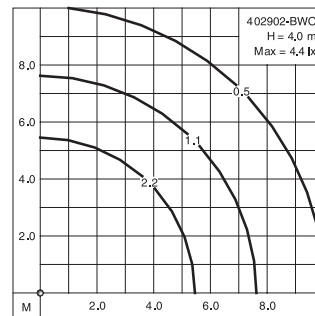
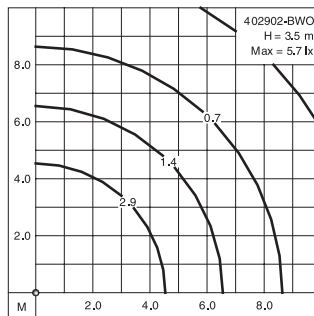
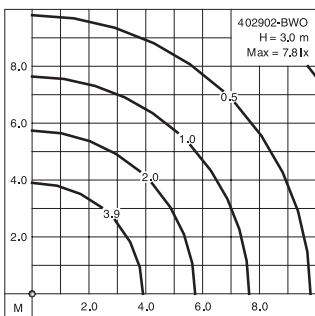
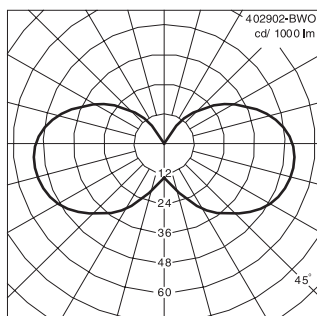
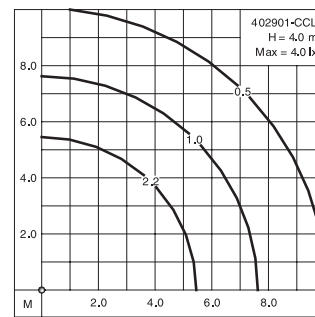
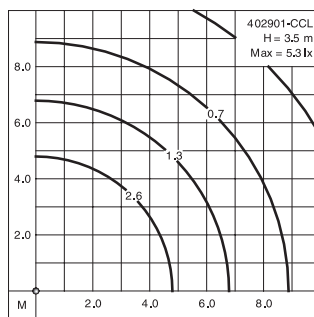
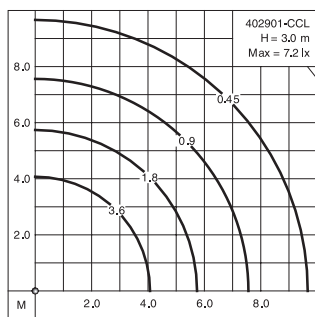
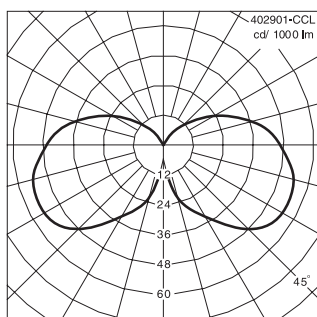

			Lumen
402901	Compact fluorescent	2G11 : 36W	2900
402902	Compact fluorescent	2G11 : 40W	3500
402903	Compact fluorescent	2G11 : 55W	4800
402904	Mercury vapour	E27 : 50W	1800
402905	Mercury vapour	E27 : 80W	3800
402906	Metal halide	E27 : 50W	2900
402907	Metal halide	E27 : 70W	4900
402908	High pressure sodium	E27 : 50W	3500
402909	High pressure sodium	E27 : 70W	5600