



Pole Top Luminaires

IP 55 Dustproof and Jetproof conforming to DIN, VDE, IEC.
Class I.

These luminaires with rotationally symmetrical light distribution are designed for pole heights of 3000-4000 mm providing a pleasant glarefree lighting suitable for private and public areas, hotels, parks, gardens and pedestrian precincts.

- Corrosion resistant die cast aluminium alloy
- Stainless steel screws
- Ultraviolet stabilized polycarbonate diffuser in clear with anti-glare bowl louver
- Weatherproof and durable silicone rubber gasket
- Integral control gear

Colour : Ultraviolet stabilized polyester powder coat finish in Black RAL 9005. Other colours are available upon consultation.

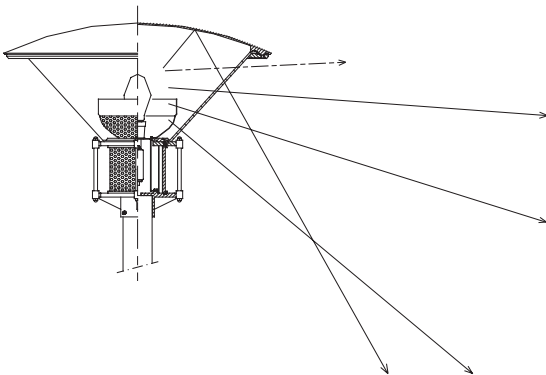

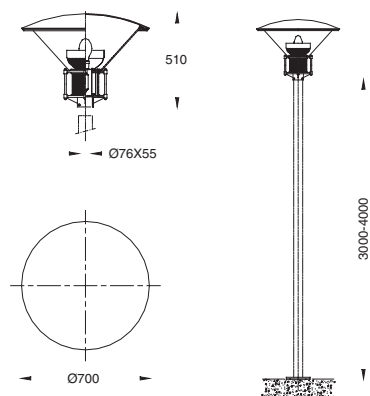
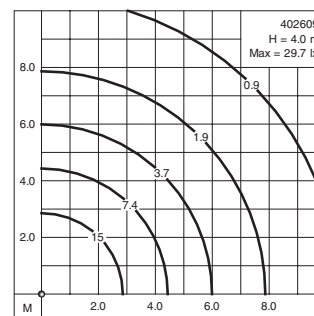
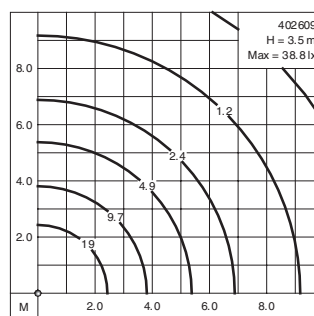
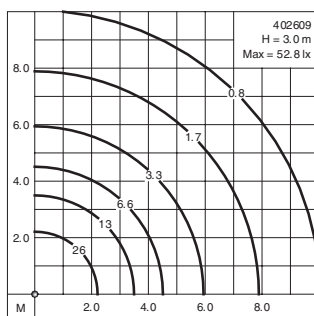
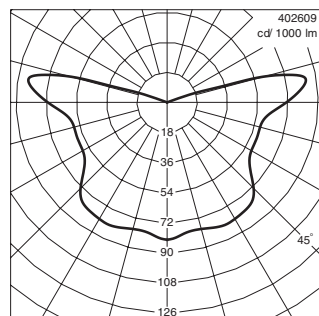
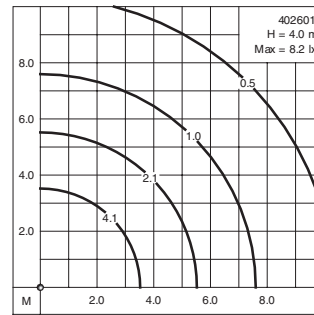
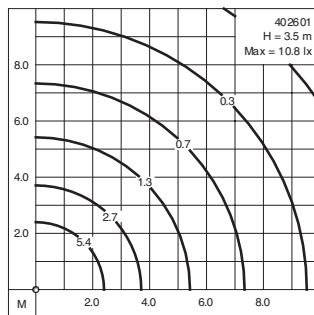
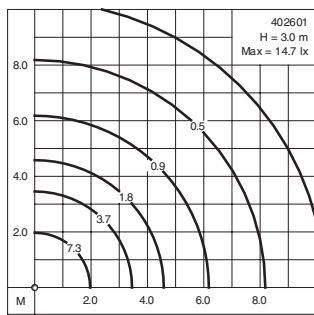
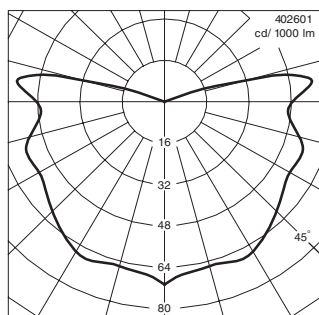

			Lumen
402601	Compact fluorescent	G24d-3 : 26W	1800
402602	Mercury vapour	E27 : 50W	1800
402603	Mercury vapour	E27 : 80W	3800
402604	Mercury vapour	E27 : 125W	6300
402605	Metal halide	E27 : 50W	2900
402606	Metal halide	E27 : 70W	4900
402607	Metal halide	E27 : 100W	8000
402608	High pressure sodium	E27 : 50W	3500
402609	High pressure sodium	E27 : 70W	5600