



Recessed / Surface - Mounted Ceiling Luminaires

Discharge lamps

IP 54 Dustproof and Splashproof conforming to DIN, VDE, IEC.
Class I.

Rectangular specular luminaires for discharge lamps, horizontally burning position, glare limitation quality class I. Luminaires with asymmetric reflector provide proper choice for controlling light forward throw at the same time producing sufficient illumination for a general lighting. Metal halide lamps are recommended for their white light, high luminous efficacy rating, very good colour rendering properties and long life service. Suitable for service petrol station canopy, commercial and industrial interiors.

Housing : corrosion resistant one piece die-formed aluminium uni-body construction completely water tight M20x1.5 cable entry diameter 7.5 to 13.5 mm.

Control gear : a separate tray but integral part of main housing accommodates ballast, ignitor, capacitor and lampholder VDE approved.

Reflector : anodized high purity aluminium reflector chemically brightened providing forward throw asymmetric light distribution.

Lens assembly : thermal shock resistant safety glass in a hinged extruded aluminium frame, stainless steel fasteners, weatherproof and durable silicone rubber gasket.

Colour : ultraviolet stabilized polyester powder coat finish in White RAL 9003. Other colours are available upon consultation.



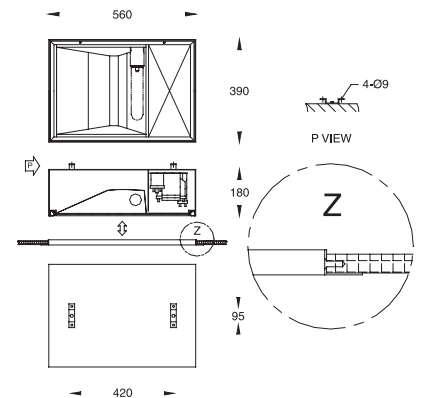
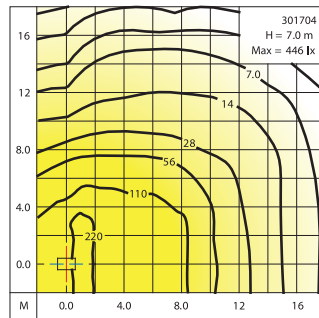
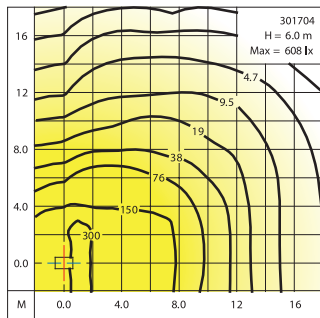
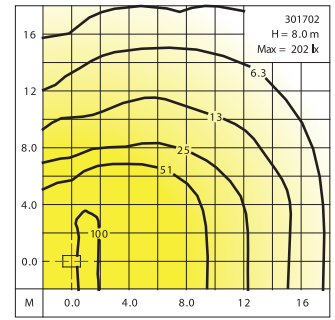
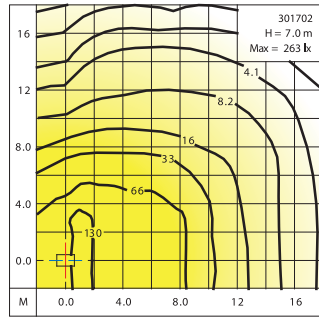
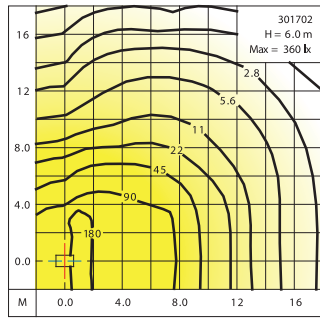
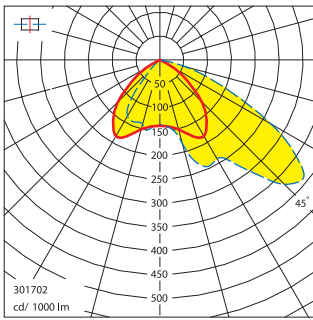

			Lumen
301701	Metal halide	E40 : T-250W	20000
301702	Metal halide	E40 : T-400W	32000
301703	High pressure sodium	E40 : T-250W	27000
301704	High pressure sodium	E40 : T-400W	48000