

Recessed / Surface - Mounted Ceiling Luminaires

Discharge lamps

IP 54 Dustproof and Splashproof conforming to DIN, VDE, IEC.
Class I.

Rectangular specular luminaires for high pressure discharge lamps, horizontally burning position, glare limitation quality class I. Luminaire with a wide beam bi-symmetric reflector directs light where it is needed at the same time producing sufficient illumination for a general lighting. Metal halide lamps are recommended for their white light, very good colour rendering properties and long service petrol life. Suitable for service station canopy, commercial and industrial interiors.

Housing : corrosion resistant one piece die-formed aluminium uni-body construction completely water tight M20x1.5 cable entry diameter 7.5 to 13.5 mm.

Control gear : a separate tray but integral part of main housing accommodates ballast, ignitor, capacitor and lampholder VDE approved.

Reflector : anodized high purity aluminium reflector chemically brightened providing wide beam bi-symmetric light distribution.

Lens assembly : thermal shock resistant safety glass in a hinged extruded aluminium frame, stainless steel fasteners, weatherproof and durable silicone rubber gasket.

Colour : ultraviolet stabilized polyester powder coat finish in White RAL 9002. Other colours are available upon consultation.



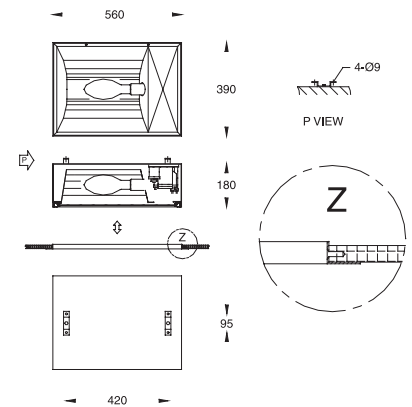
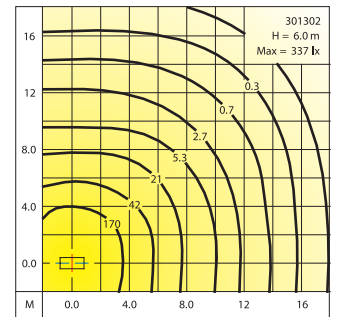
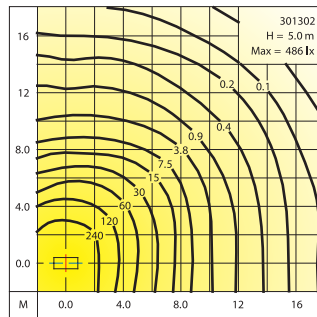
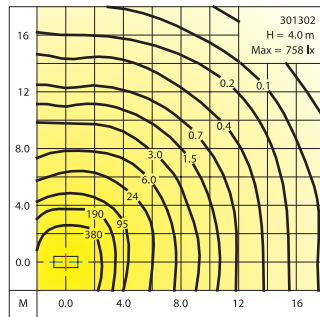
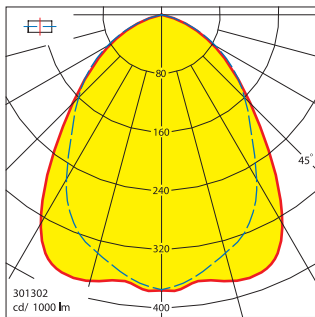
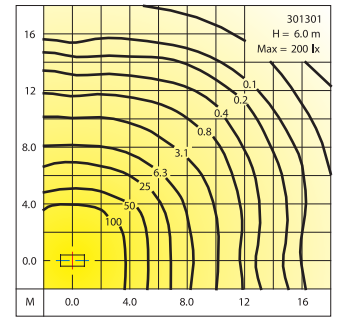
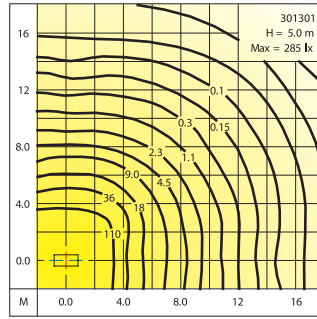
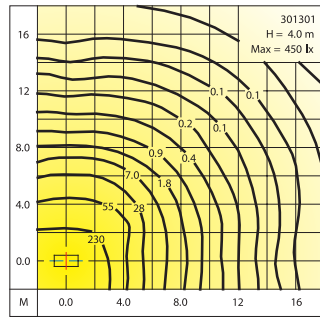
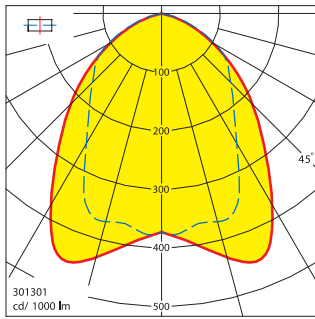

			Lumen
301301	Metal halide	E40 : E-250W	19000
301302	Metal halide	E40 : E-400W	32000
301303	High pressure sodium	E40 : E-250W	25000
301304	High pressure sodium	E40 : E-400W	47000